

The one-dimensional adiabatic flow of equilibrium gas–particle mixtures in variable-area ducts with friction

By GUIDO BURESTI¹ AND CLAUDIO CASAROSA²

¹Dipartimento di Ingegneria Aerospaziale, Università di Pisa, Via Diotisalvi 2, 56126 Pisa, Italy

²Dipartimento di Energetica, Università di Pisa, Via Diotisalvi 2, 56126 Pisa, Italy

(Received 26 August 1992 and in revised form 26 April 1993)

A general one-dimensional model for the steady adiabatic motion of gas–particle mixtures in arbitrarily oriented ducts with gradually varying cross-section and wall friction is presented. The particles are assumed to be incompressible and in thermomechanical equilibrium with a perfect gas phase, and the effects of their finite volume and of gravity are also taken into account.

The equations of motion are written in a form that allows a theoretical analysis of the behaviour of the solutions to be carried out. In particular, the results of the application to the model of a procedure that permits the identification and the topological classification of the singular points of the trajectories representing, in a suitable phase space, the solutions of the set of equations defining the problem are described. This characterization of the singular points is useful in order to overcome difficulties in the numerical integration of the equations.

Subsequently, a geometrical analysis is carried out which allows a study of the signs of the local variations of the flow quantities, and shows that some unusual behaviour may occur if certain geometrical and fluid dynamic conditions are fulfilled. For instance, in an upward motion it is possible to have a simultaneous decrease of velocity, pressure and temperature, while in a downward flow an increase of all these quantities may be found. It is also shown that conditions exist in which expansion and heating of the mixture may take place simultaneously, both in accelerating and decelerating flows.

The model is applied to the study of upward motion in particular ducts, having converging–diverging and constant-diverging cross-sections; to this end the equations are integrated numerically by using the Mach number as the independent variable. The results show that even limited variations of the duct diameter may give rise to significant qualitative and quantitative variations in the flow conditions inside the duct and in the mass flow rate. Finally, an example is given of a subsonic downward flow in which a simultaneous increase of pressure, temperature and velocity occurs even in the case of a pure perfect gas.

1. Introduction

The analysis of the motion of gas–particle mixtures in ducts is of significant interest in the solution of many engineering problems, and, depending on the degree of approximation required in the specific application, may be carried out through mathematical models of different sophistication (see Wallis 1969; Boothroyd 1971; Rudinger 1976; Crowe 1982; Soo 1989).

In previous works (Buresti & Casarosa 1987, 1989) the authors described a one-dimensional model for the analysis of the adiabatic, steady, upward motion of gas-particle mixtures in vertical constant-area ducts with friction, also taking into consideration the effects of gravity and of the finite volume of the particles. In that model the particles were assumed to be incompressible and in thermomechanical equilibrium with a perfect gas. One of the consequences of the assumptions was shown to be that the pressure drop in choked flows may be a minimum for small but non-zero values of the loading ratio η (which is the ratio between the mass flow rates of the particles and of the gas). Also, the possibility of an adiabatic heating of the mixture in a subsonic expansion was theoretically predicted for certain inlet conditions.

The model was originally conceived for a volcanological application, namely the approximate description of the conditions existing in portions of volcanic conduits during the Plinian phases of explosive eruptions. Indeed, the model may be used to study the behaviour of the magmatic fluid in volcanic conduits during sufficiently intense eruptions and above the disruption region, where highly fragmented incompressible particles are expected to be carried by the exsolved gas phase (generally water vapour and carbon dioxide). Previous one-dimensional homogeneous flow models for the analysis of this problem either neglected gravity, wall friction and volume of the particles (Kieffer 1982), or assumed the flow to be isothermal and the pressure along the conduit to be lithostatic (Wilson, Sparks & Walker 1980; Wilson & Head 1981). Subsequently, Giberti & Wilson (1990) did allow for different pressure variations with assumed conduit geometries, while Dobran (1992) developed a more general non-equilibrium model, but they still considered the flow to be isothermal. However, as already pointed out by Buresti & Casarosa (1989), the isothermal flow assumption may be questionable when variable-area ducts, allowing the flow to expand to supersonic velocities, are considered; and, in any case, it is important to check the degree of approximation of this assumption in different flow conditions, in order to derive the limits of applicability of the isothermal non-equilibrium codes. Conversely, the assumption of adiabatic flow is certainly justified in volcanological applications; indeed, a quick approximate evaluation may easily show that after the very first period of flow (to which a steady-state model cannot be applied) an additional term describing the heat transfer between the magmatic fluid and the rock would be at least one order of magnitude smaller than the remaining terms of the energy equation.

In the present paper a generalization of the adiabatic, homogeneous flow model of Buresti & Casarosa (1987, 1989) to variable-area ducts is presented, which may be applied provided the variation of the cross-section of the duct is sufficiently gradual; this is not only because of the assumption of one-dimensional flow, but also to fulfil the conditions of thermomechanical equilibrium between particles and gas, which have been thoroughly discussed by Buresti & Casarosa (1989). Moreover, in order to derive a completely general one-dimensional treatment of the flow of homogeneous gas-particle mixtures, not limited to the volcanological application, the model is extended to flow in ducts of any orientation, so that it may actually be used in very general conditions of motion, provided they are such that the assumption of thermomechanical equilibrium between gas and particles is satisfied with sufficient accuracy. Actually, it will be shown that the model may also be applied to the analysis of the one-phase flow of real gases, if they fulfil certain thermodynamic conditions.

The general character of the treatment allows a considerable amount of information to be derived from a theoretical discussion of the equations. In particular, a methodology is used to determine the positions and the topological classification of the singular points of the trajectories representing, in a suitable phase space, the solutions

of the set of equations defining the problem. The importance of this analysis, which is carried out following the procedures described by Bilicki *et al.* (1987), is that numerical methods become largely inadequate in the neighbourhood of these singular points, so that it is extremely useful to identify them and to use appropriate means to overcome the numerical difficulties.

Subsequently, all the possible combinations of the signs of the local variations of the main flow quantities (i.e. velocity, pressure and temperature) are derived as a function of the local flow conditions. This analysis is accomplished by using geometrical tools, and demonstrates that the assumption of non-negligible gravity effects and the particular form of the equation of state of the mixture may both give rise to possible trends in the flow quantities that are substantially different from those which may be obtained from the classical one-dimensional gasdynamics of perfect gases.

Finally, the model is applied to the study of the upward motion of gas-particle mixtures in particular ducts, with converging-diverging or constant-diverging cross-sections. As will be seen, these applications demonstrate the high sensitivity of the flow features to even limited cross-sectional variations.

2. Description of the model

2.1. Basic assumptions

The basic assumptions of the model are:

- (a) the mixture is homogeneous and composed of incompressible particles, in thermal and mechanical equilibrium with a perfect gas carrier phase;
- (b) no mass exchange exists between the phases;
- (c) the flow is one-dimensional, steady, adiabatic;
- (d) the cross-section of the duct varies gradually.

The implications of the first three assumptions, and their limits of applicability for the analysis of high-pressure flows of gas-particle mixtures, were thoroughly discussed by Buresti & Casarosa (1989). In particular it was shown that the model implies that the effects of particle-wall and particle-particle interactions may be taken into account through an appropriate modification of the value of the friction coefficient at the duct wall. Furthermore, the following conditions must be satisfied:

$$\tau_v \ll L/U, \quad (1)$$

$$\tau_T \ll L/U, \quad (2)$$

$$|V_g - V_p| \ll U, \quad (3)$$

where τ_v and τ_T are, respectively, the velocity and temperature relaxation times of the particles, $|V_g - V_p|$ is the absolute value of the velocity difference between the gas and the particles (i.e. the so-called slip velocity), and L and U are a reference dimension and a characteristic velocity of the mixture, referred either to the whole duct or to those portions of it where considerable gradients are present.

In fact, while the slip velocity and temperature jump may never be exactly zero in a gas-particle mixture subjected to accelerations or to the effects of the gravity force component, in practice the assumption of perfect thermomechanical equilibrium between the particles and the conveying gas phase may be an acceptable approximation if conditions (1)–(3) are fulfilled, and this normally implies that an upper limit must be set on the allowed size of the particles.

As will be clear from the results of the present extension of the model, a further implication is contained in assumption (d), i.e. that the cross-section of the duct vary

sufficiently gradually, in order to avoid excessive local velocity gradients, and to keep the approximation of one-dimensional flow applicable.

Finally, it should be pointed out that, as derives from the analysis of the following section, the model may actually be applied also to the study of the one-phase flow of a real gas having a particular form of the equation of state, which is thermodynamically equivalent to that of the gas-particle mixture.

2.2. Description of the mixture

For a complete thermodynamic description of the mixture reference should be made to Buresti & Casarosa (1989); here only the main points will be reported.

By introducing the mass fraction, ϕ , i.e. the mass of the condensed phase contained in unit mass of the mixture, the density of the mixture, ρ_m , may be obtained as a function of the densities of the gas and of the particles, respectively ρ_g and ρ_p , from the relation

$$\frac{1-\phi}{\rho_g} + \frac{\phi}{\rho_p} = \frac{1}{\rho_m}, \quad (4)$$

so that, considering that the gas phase is a perfect gas, the equation of state of the mixture becomes

$$p = \frac{\rho_m R_m T}{1 - \phi(\rho_m/\rho_p)}, \quad (5)$$

where the quantity R_m is given as a function of the gas-phase constant, R_g , by

$$R_m = (1 - \phi) R_g. \quad (6)$$

If C is the specific heat of the solid particles and the suffix g refers to the gas phase, it is easy to derive for the specific heats of the mixture

$$\frac{C_{p_m}}{C_{v_m}} = k_m = k_g \frac{1 - \phi + \phi(C/C_{p_g})}{1 - \phi + \phi k_g(C/C_{p_g})}, \quad (7a)$$

$$C_{p_m} - C_{v_m} = R_m, \quad (7b)$$

while the differentials of the internal energy, enthalpy and entropy of the mixture may be written

$$du_m = C_{v_m} dT, \quad (8)$$

$$dh_m = C_{p_m} dT + \phi \frac{dp}{\rho_p}, \quad (9)$$

$$dS_m = C_{p_m} \frac{dT}{T} - R_m \frac{dp}{p}. \quad (10)$$

Finally, the expression for the velocity of sound of the mixture, with the assumption of equilibrium flow, is

$$a_m = \left[\left(\frac{\partial p}{\partial \rho_m} \right)_{S_m} \right]^{\frac{1}{2}} = \frac{(k_m R_m T)^{\frac{1}{2}}}{1 - \phi(\rho_m/\rho_p)}. \quad (11)$$

It should now be pointed out that if the equation of state of the mixture is recast in the form

$$\frac{p}{\rho_m R_m T} = 1 + \frac{\phi}{\rho_p R_m T} p \quad (12)$$

then it may be interpreted as a form of the virial equation, truncated at the second term (Abbott & Van Ness 1972; Van Wylen & Sonntag 1976).

Indeed, the term on the right-hand-side of (12) represents the so-called 'compressibility factor' of a 'real' gas characterized by the molecular weight

$$\mathcal{M} = \frac{\mathcal{M}_g}{1-\phi}, \quad (13)$$

where \mathcal{M}_g denotes the molecular weight of the gas phase.

The second virial coefficient of this gas is then

$$B = \frac{\phi}{1-\phi} \frac{\mathcal{M}_g}{\rho_p} \geq 0 \quad (14)$$

and may describe the behaviour of a gas at temperatures above its Boyle temperature (Van Wylen & Sonntag 1976), in the range from low to moderate pressures.

If the specific heat of the gas is now assumed to be equal to that of the mixture, C_{p_m} , the residual functions (i.e. the differences between the perfect and real gas thermodynamic properties, at the same temperature and pressure, Abbott & Van Ness 1972) may be derived from the results of classical thermodynamics. In particular, (9) and (10) are again found, provided it is remembered that in our case the second virial coefficient is constant.

These considerations show that the present treatment may have an application range that is somewhat wider than that of homogeneous gas-particle mixtures. However, the limitation to gases at temperatures higher than the Boyle temperature (which is connected with the fact that in our case B is positive) is certainly a stringent one from a physical point of view, because most gases are characterized by Boyle temperatures well above their critical temperatures. A generalization of the treatment to negative values of B might be carried out without difficulty, but in that case a value of B independent of temperature would be a poor representation of the actual behaviour of real gases (Abbott & Van Ness 1972; Van Wylen & Sonntag 1976).

2.3. Equations of motion

It may be useful to introduce the loading ratio of the mixture, η , i.e. the ratio between the mass flow rates of particles and gas, G_p and G_g ; this quantity is constant along the duct owing to the steadiness of the flow. By considering also the assumed mechanical equilibrium between the two phases, we have then

$$\eta = \frac{G_p}{G_g} = \frac{\phi}{1-\phi}. \quad (15)$$

By imposing the balances of mass, momentum and energy, the equations of motion may now be written in differential form as

$$\frac{d\rho_m}{\rho_m} + \frac{dV}{V} + \frac{dA}{A} = 0, \quad (16)$$

$$\rho_m V dV + dp + \rho_m \left(g + \frac{4f}{D} \frac{1}{2} V^2 \right) dz = 0, \quad (17)$$

$$C_{p_m} dT + \frac{\eta}{1+\eta} \frac{dp}{\rho_p} + d\left(\frac{1}{2} V^2\right) + g dz = 0, \quad (18)$$

where V is the velocity of the mixture, A is the cross-section of the duct, D its hydraulic diameter, f the wall friction coefficient, and z is the (always positive) coordinate along the duct in the direction of motion.

The parameter g may be defined by the relation $g = g^* \cos \theta$, where g^* is the acceleration due to gravity and θ the angle between the axis of the duct, directed as the flow, and an upward positive vertical coordinate. In particular, upward and downward vertical flows are respectively described by $g = g^*$ and $g = -g^*$, while the condition of horizontal flow corresponds to $g = 0$.

It is now expedient to introduce the Mach number $M = V/a_m$, and to differentiate it, in order to obtain the following auxiliary equation (which is equivalent to equation (28) of Buresti & Casarosa 1989):

$$\frac{dM}{M} = \frac{dV}{V} - \frac{1 - \eta\rho_g/\rho_p}{1 + \eta\rho_g/\rho_p} \frac{dT}{2T} - \frac{\eta\rho_g/\rho_p}{1 + \eta\rho_g/\rho_p} \frac{dp}{p}, \quad (19)$$

where use was made of the following relation, linking the density of the mixture to the densities of the gas and condensed phases and to the loading ratio:

$$\rho_m = \rho_g \frac{1 + \eta}{1 + \eta(\rho_g/\rho_p)}. \quad (20)$$

The equations of motion may now be manipulated in order to express explicitly the local variations of velocity, pressure and temperature along the duct, obtaining

$$\frac{dV}{V} = \frac{1}{1 - M^2} \Phi_V dz, \quad (21)$$

$$\frac{dp}{p} = \frac{k_m}{M^2 - 1} (1 + \eta\rho_g/\rho_p) \Phi_p dz, \quad (22)$$

$$\frac{dT}{T} = \frac{k_m - 1}{M^2 - 1} (1 + \eta\rho_g/\rho_p) \Phi_T dz, \quad (23)$$

where the following definitions have been introduced:

$$\Phi_V := \frac{4}{D} \left\{ [1 + (k_m - 1)(1 + \eta\rho_g/\rho_p)]^{\frac{1}{2}} f M^2 + \frac{gD}{4a_m^2} - \frac{D}{4A} \frac{dA}{dz} \right\}, \quad (24)$$

$$\Phi_p := \frac{4}{D} \left\{ [1 + (k_m - 1)(1 + \eta\rho_g/\rho_p) M^2]^{\frac{1}{2}} f M^2 + \frac{gD}{4a_m^2} - \frac{D}{4A} \frac{dA}{dz} M^2 \right\}, \quad (25)$$

$$\Phi_T := \frac{4}{D} \left\{ [1 + (k_m M^2 - 1)(1 + \eta\rho_g/\rho_p)]^{\frac{1}{2}} f M^2 + \frac{gD}{4a_m^2} - \frac{D}{4A} \frac{dA}{dz} M^2 \right\}. \quad (26)$$

Equations (21)–(26) are a generalization to the motion in arbitrarily oriented variable-area ducts of those already derived by Buresti & Casarosa (1989) for the upward motion of equilibrium gas–particle mixtures in constant-section ducts. They are quite general, so that many particular cases can easily be derived. For instance, in flows of dilute mixtures at moderate pressures, the volume of the particles may be neglected by putting $\rho_p = \infty$. As can immediately be seen from (5), with this assumption the mixture becomes a ‘perfect pseudogas’, with a modified constant R_m given, as a function of the particle content and of the gas-phase constant, by relation (6). In these conditions, the behaviour of the mixture is qualitatively similar to that of

the case of a pure gas, which on the other hand may be immediately recovered from the complete equations by putting $\eta = 0$.

3. Discussion of the equations

3.1. Preliminary remarks

Equations (21)–(26) form a set of nonlinear ordinary differential equations, which, with the initial conditions that at $z = 0$ the values of the variables V , p and T are given, in principle permits the solution of the general problem of evaluating the motion of a homogeneous gas-particle mixture in thermomechanical equilibrium along a duct of assigned geometry. Also, considering that (24)–(26) are local functions of the Mach number and of the thermodynamic conditions of the mixture, i.e. of p and T , with the aid of (19) it is possible to recast the set of equations in such a manner that the Mach number is used as the independent variable, and the quantity z/D treated as one of the unknowns, a procedure already introduced by Shapiro (1953) and Buresti & Casarosa (1989).

However, save for a few particular cases, the integration of these equations can normally be carried out only through numerical methods. This may give rise to some difficulties, particularly in the neighbourhood of the sections where $M = 1$, in which, unless we have the simultaneous vanishing of (24)–(26), equations (21)–(23) have a singularity; therefore, the problem exists of the compatibility of the initial conditions with the geometrical and fluid dynamic constraints that must be fulfilled for the crossing of the critical sonic conditions.

More explicitly, it is easy to see that $\Phi_V(M = 1) = \Phi_p(M = 1) = \Phi_T(M = 1)$, so that the flow through a section where $M = 1$ is possible only provided these functions vanish at least as $(M^2 - 1)$; in other words the following fundamental relation must be satisfied:

$$\frac{D}{4A} \frac{dA}{dz} = \frac{1}{2} f [1 + (k_m - 1)(1 + \eta \rho_g / \rho_p)] + \frac{gD}{4a_m^2}. \quad (27)$$

A more general type of analysis of the topological classification of the points representing, in a suitable phase space, the solutions of the equations of motion, may be carried out through techniques similar to those described by Bilicki *et al.* (1987). This study, which is reported in the next section, permits the identification of the singular points, of their topological nature, and of the directions that must be followed in the numerical integration when passing through such critical conditions.

The prediction of the signs of the local variations of the flow quantities along the duct as a function of the geometrical parameters and of the local flow conditions is another useful outcome that may derive from the analysis of the equations of motion. Indeed, from a comparison of the results of this study with those typical of the flow of a perfect gas, the influence of the equation of state of a fluid on the possible thermodynamic transformations to which it may be subject during the flow can be discussed. Such an analysis has already been carried out by Buresti & Casarosa (1989) for the case of upward motion in constant-section ducts, and has demonstrated that, in certain conditions, the heating of the mixture in a subsonic expansion may occur.

However, for a variable-area duct with generic orientation the derivation of the possible signs of the local variations of velocity, pressure and temperature is much more involved. Indeed, the main difference between the present case and that of vertical upward motion in constant-section ducts is that now the effects of gravity are no longer necessarily additive to those of friction, because for downward flow we have $g < 0$, so

that the signs of the two terms connected with friction and gravity appearing in (24)–(26) are opposite. Furthermore, the term deriving from the variation of area may obviously be either positive or negative, according to the local geometry of the duct.

By following a procedure similar to that used for constant-section ducts, Buresti & Casarosa (1990) described many different possible cases for the upward motion in variable-area ducts; however, a synthesis of these results may not be immediately apparent. In §3.3 a different geometrical procedure will be developed which should facilitate, with the aid of graphical support, the simultaneous identification of the signs of the variations of velocity, pressure and temperature corresponding to given local flow conditions and geometrical parameters. Since it will be shown that in certain circumstances some of the trends of the flow quantities may be rather unusual, this discussion might also be of help in checking the correctness of the behaviour of numerical results.

3.2. Topological analysis

Following the treatment of Bilicki *et al.* (1987), the equations of the one-dimensional motion of a gas–particle mixture along a duct with axial coordinate z may be put in the form

$$\sum_{j=1}^n A_{ij}(\mathbf{v}) \frac{dv_j}{dz} = b_i(z, \mathbf{v}) \quad (i = 1, 2, \dots, n), \quad (28)$$

where \mathbf{v} is a vector whose n components are dynamic and thermodynamic physical quantities v_j (for instance, V , p , and T), which are functions of z .

Each solution of the problem given by the system of coupled, ordinary, nonlinear differential equations (28), together with suitable initial conditions, represents a trajectory $\mathbf{v}(z)$ in the phase space Ω of $(n+1)$ dimensions consisting of z and of the n components of \mathbf{v} . Equation (28) defines a vector field $\mathbf{W}(z, \mathbf{v})$ in Ω , each vector of which is tangential to the corresponding trajectory, and whose direction is given by the n angles α_j such that

$$\tan \alpha_j = \frac{dv_j}{dz} = \frac{N_j(z, \mathbf{v})}{\Delta(\mathbf{v})} = \sum_{i=1}^n A_{ji}^{-1} b_i, \quad (29)$$

where $\Delta(\mathbf{v}) = \det [A_{ij}]$, $N_j(z, \mathbf{v})$ are the determinants obtained from $[A_{ij}]$ by replacing the j th column by b_i , and A_{ij}^{-1} are the components of the inverse matrix $[A_{ij}]^{-1}$.

Δ , N_1, \dots, N_n are the components of the vector $\mathbf{W}(z, \mathbf{v})$, whose directional angles are α_j , and which may be interpreted as the velocity with which a point moves along the trajectory, if a parameter t along it is arbitrarily defined, so that

$$\frac{dz}{dt} = \Delta(\mathbf{v}); \quad \frac{dv_j}{dt} = N_j(z, \mathbf{v}). \quad (30)$$

It should be pointed out that the components of the $n \times n$ matrix $[A_{ij}]$ do not contain the space variable z .

The points in the phase space may now be given the following classification:

regular points (z_0, \mathbf{v}_0) when $\Delta(\mathbf{v}_0) \neq 0$;

turning points (z^*, \mathbf{v}^*) when $\Delta(\mathbf{v}^*) = 0$, $N_j(z^*, \mathbf{v}^*) \neq 0$;

singular points (z^{**}, \mathbf{v}^{**}) when $\Delta(\mathbf{v}^{**}) = 0$, $N_j(z^{**}, \mathbf{v}^{**}) = 0$.

On the set of regular points the two systems (28) and (29) are equivalent, and the conditions for existence and uniqueness of the solutions are satisfied.

A trajectory passing through a turning point has a maximum there, a minimum in z , or a point of inflexion. At the end section of a constant or converging duct with an equilibrium gas–particle mixture flow, a turning point corresponds to a maximum, and to the occurrence of choked conditions (Buresti & Casarosa 1989, 1990).

Singular points represent the equilibrium points of the system (30), i.e. correspond to $W = 0$, and are *non-degenerate* if the rank of the matrix $[A_{ij}(v^{**})]$ is $(n - 1)$, which is its maximum value, on account of the condition $\Delta(v^{**}) = 0$.

It may be demonstrated (Bilicki *et al.* 1987) that if $\Delta = 0$ and $N_1 = 0$, then $N_2, \dots, n = 0$, i.e. all the hypersurfaces $N_j = 0$ intersect the hypercylinder $\Delta = 0$ along the same manifold. Furthermore, it can also be shown that non-degenerate singular points have the same nature as those of linear systems, because their topological structure may be studied by analysing the linearized form of the system (30) in correspondence with the singular points. This linearized form is

$$\frac{dX_\alpha}{dt} = \sum_{\beta=1}^{n+1} E_{\alpha\beta} X_\beta, \tag{31}$$

in which X_α has components $[z - z^{**}, v_j - v_j^{**}]$, and $[E_{\alpha\beta}]$ ($\alpha, \beta = 1, 2, \dots, n + 1$) is the Jacobian matrix (evaluated in z^{**}, v^{**})

$$[E_{\alpha\beta}] = \begin{bmatrix} 0 & \frac{\partial \Delta}{\partial v_1} & \dots & \frac{\partial \Delta}{\partial v_n} \\ \frac{\partial N_1}{\partial z} & \frac{\partial N_1}{\partial v_1} & \dots & \frac{\partial N_1}{\partial v_n} \\ \dots & \dots & \dots & \dots \\ \frac{\partial N_n}{\partial z} & \frac{\partial N_n}{\partial v_1} & \dots & \frac{\partial N_n}{\partial v_n} \end{bmatrix}. \tag{32}$$

It may be shown (Bilicki *et al.* 1987) that $[E_{\alpha\beta}]$ has $(n - 1)$ zero eigenvalues and two non-zero eigenvalues, $A_1 \neq A_2$, which may be determined from the equation

$$A^2 - sA + q = 0, \tag{33}$$

where

$$s = \sum_{\alpha=1}^{n+1} E_{\alpha\alpha}, \tag{34}$$

$$q = \sum_{1 \leq \alpha < \beta \leq n+1} (E_{\alpha\alpha} E_{\beta\beta} - E_{\alpha\beta} E_{\beta\alpha}). \tag{35}$$

According to the values of A_1 and A_2 , the singular points have different topological characters, as summarized in figure 1 (see Kaplan 1958).

When A_1 and A_2 are real, i.e. when the singular point is a saddle or a node, then the eigenvectors corresponding to A_1 and A_2 define two characteristic directions passing through the singular point. The importance of this is that numerical calculations in the neighbourhood of the singular point must then follow these directions.

Conversely, when A_1 and A_2 are complex conjugate, then the singular point is a spiral (or focus), and no trajectory passes through it. Trajectories around spirals cross the line $\Delta = 0$ at many points, which represent turning points, and, in one-dimensional flow models, correspond to the occurrence of choking.

We may now apply this procedure to the model of §2; the details of this application are given by Buresti & Casarosa (1992), and here only the main points will be described.

For the analysis we will use the four-dimensional phase space composed of the coordinate z , the velocity V , the pressure p and the temperature T . By using the differential form of the equation of state, and expressing the density of the mixture as a function of p and T , it is easy to see that the equations of motion (16)–(18) may be

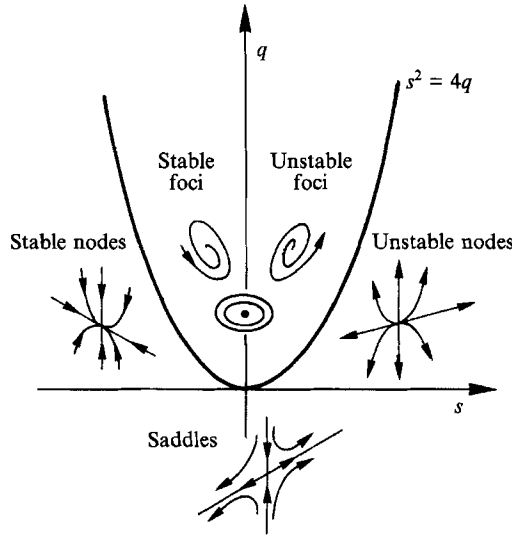

FIGURE 1. Topological classification of singular points (Kaplan 1958).

recast in the form (28). If we then evaluate the determinants Δ , N_V , N_p , N_T , we obtain after a few algebraic manipulations (Buresti & Casarosa 1992)

$$\Delta = \frac{C_{p_m}}{V} (M^2 - 1), \quad (36)$$

$$N_V = -C_{p_m} \Phi_V, \quad (37)$$

$$N_p = C_{p_m} V \rho_m \frac{\Phi_p}{M^2}, \quad (38)$$

$$N_T = \frac{V}{1 + \eta \rho_g / \rho_p} \frac{\Phi_T}{M^2}, \quad (39)$$

so that, after further efforts, (21)–(23) can be recovered from the application of (29), which in this case are written

$$\frac{dV}{dz} = \frac{N_V}{\Delta}, \quad (40)$$

$$\frac{dp}{dz} = \frac{N_p}{\Delta}, \quad (41)$$

$$\frac{dT}{dz} = \frac{N_T}{\Delta}. \quad (42)$$

These results allow new light to be shed on the discussion of §3.1. Indeed, the critical condition $M = 1$ is seen to correspond to $\Delta = 0$, i.e. to the fact that the solution point in the phase space belongs to a cylindrical hypersurface whose generators are parallel to the z -axis.

If, when the condition $\Delta = 0$ occurs, the determinants N_p , N_V , N_T are not zero, the point is a *turning point*, and must necessarily correspond to the final section of the duct, because there the trajectory reaches a maximum in z ; we have then the condition of choking already described by Buresti & Casarosa (1989). Conversely, if $N_p = N_V =$

$N_T = 0$, the point is a *singular point*, and its occurrence is seen to correspond to the fulfilment of condition (27); incidentally, it should be noted that, taking into account (36)–(39) and that $\Phi_v(M = 1) = \Phi_p(M = 1) = \Phi_T(M = 1)$, it is straightforward to recover the already mentioned condition, derived by Bilicki *et al.* (1987), that if $\Delta = 0$ and, say, $N_v = 0$, then we have also $N_p = N_T = 0$.

The topological classification of a singular point may be determined from the linearized analysis described above. The application of that analysis to the present problem is carried out in detail by Buresti & Casarosa (1992), where, for simplicity and without any significant loss of generality, the duct is assumed to be of circular cross-section with diameter D , so that $A'/A = 2D'/D$ (where the prime now indicates derivation with respect to z). Through that analysis it is possible to obtain the coefficients of the fundamental equation (33), which gives the two non-zero eigenvalues of the matrix $[E_{\alpha\beta}]$ defined in (32). In the present case it can be shown that the quantities s and q appearing in (33) are given by the expressions

$$s = -\frac{2C_{p_m} f}{a_m D} [1 + (k_m - 1)(1 + \eta\rho_g/\rho_p)][2 + (k_m - 1)(1 + \eta\rho_g/\rho_p)] \quad (43)$$

and

$$q \left[\frac{D^2 T(1 + \eta\rho_g/\rho_p)}{8C_{p_m}} \right] = -\frac{D'' D k_m + 1}{4 k_m - 1} + \left(\frac{gD}{2a_m^2} \right)^2 \left[1 + \frac{1 k_m + 1}{4 k_m - 1} + \frac{2\eta\rho_g/\rho_p}{(k_m - 1)(1 + \eta\rho_g/\rho_p)} \right] \\ + \left(\frac{gD}{2a_m^2} \right) f \left\{ \frac{1 k_m + 1}{4 k_m - 1} [1 + (k_m - 1)(1 + \eta\rho_g/\rho_p)] + \frac{2\eta\rho_g/\rho_p}{(k_m - 1)(1 + \eta\rho_g/\rho_p)} \right\} \\ - f^2 \frac{\eta\rho_g}{\rho_p} [1 + (k_m - 1)(1 + \eta\rho_g/\rho_p) + \frac{1}{2} k_m (k_m - 1)(1 + \eta\rho_g/\rho_p)^2]. \quad (44)$$

Expressions (43) and (44) allow the topological nature of a singular point to be obtained for the general case of the one-dimensional flow of a homogeneous gas-particle mixture in a variable-area duct with any attitude. Indeed, the quantities s and q may be evaluated from the local geometrical and thermodynamical quantities D , D'' , p and T (from which a_m and ρ_g may be derived), and the nature of the singular point may then be immediately obtained from figure 1. If, as will often be the case, the point is a saddle, then from the real eigenvalues Λ_1 and Λ_2 which satisfy (33) two eigenvectors may be derived defining two characteristic directions in the Ω -space, and the numerical calculations must then be carried out from the singular point with a step along one of these directions. The choice between these directions is dependent on the problem under consideration, and in particular on the downstream boundary conditions.

It is interesting to point out that the value of s does not depend on the attitude of the duct, i.e. on the value of g . Furthermore, s can never be positive, and if friction is taken into account, it is always negative. Consequently (see figure 1), the singular points may only be *saddles* (if $q < 0$), *stable nodes* ($q > 0$, $s^2 - 4q > 0$), or *stable foci* ($q > 0$, $s^2 - 4q < 0$); only in the first two cases do trajectories of the solutions in the phase space cross the singular points.

Conversely, the sign of the quantity q is in general dependent on the value of the second derivative of the function $D(z)$, on the attitude of the duct, and on the friction coefficient. However, a deeper analysis of the right-hand side of (44) shows that the first term, connected with D'' , is often the prevailing one, so that the geometry of the duct is the main factor affecting the existence and the nature of the singular points.

We may now analyse some particular cases that may be of interest as reference conditions and also from an application point of view. For instance, if the volume of the particles is neglected (i.e. $\rho_p = \infty$), then

$$s = -\frac{2C_{p_m} f}{a_m D} k_m (k_m + 1), \quad (45)$$

$$q = \frac{8C_{p_m}}{D^2 T} \left\{ -\frac{D'' D k_m + 1}{4 k_m - 1} + \left(\frac{gD}{2a_m^2} \right)^2 \left[1 + \frac{1}{4} \frac{k_m + 1}{k_m - 1} \right] + \left(\frac{gD}{2a_m^2} \right) f \frac{k_m k_m + 1}{4 k_m - 1} \right\}. \quad (46)$$

This relation confirms that in this case the mixture behaves like a perfect gas, with the particle loading ratio influencing only the values of the thermodynamic quantities k_m , C_{p_m} and a_m , not the structure of the expressions. Furthermore, if the duct is horizontal q does not depend on friction, and its sign is connected only with the sign of D'' . Obviously it should be remembered that the location of the singular point along the duct does depend on friction, and is given by (27), which, for $\rho_p = \infty$ and motion in a horizontal circular-section duct, becomes simply

$$D' = f k_m. \quad (47)$$

In this particular case we have then

$$q = -\frac{2C_{p_m} D'' k_m + 1}{DT k_m - 1}. \quad (48)$$

Since $s < 0$, the singular point is a saddle if $D'' > 0$. Conversely, if $D'' < 0$ it is necessary to discuss the sign of the quantity $\Psi = s^2 - 4q$. After some manipulations it is easy to find

$$\Psi = \frac{4C_{p_m} k_m + 1}{DT k_m - 1} \left[\frac{f^2 k_m^2 (k_m + 1)}{D} + 2D'' \right]. \quad (49)$$

We have then that $\Psi > 0$ (and the singular point is a stable node) if

$$\frac{f^2 k_m^2 (k_m + 1)}{2D} < D'' < 0. \quad (50)$$

With the usual values of the friction coefficient (of the order of 0.01), it is clear that condition (50) may seldom be satisfied, so that for $D'' < 0$ a singular point would normally be a focus. However, as already pointed out, trajectories in the solution space, such as those that might be followed in a numerical calculation, would never reach a focus, as before this may happen the line $\Delta = 0$ would have already been crossed at least once, with a consequent choking of the flow. Indeed, the relevance of the possible presence of a stable focus in the Ω -space is that it may lead to choking conditions even in trajectories not passing through any singular point (Bilicki *et al.* 1987).

Further particular cases, such as the inviscid motion of a mixture or of a perfect gas in horizontal or vertical flows, may easily be derived from the general expressions (43) and (44).

3.3. Geometrical analysis

If we return to (21)–(23), it is immediately recognized that the signs of the local variations of the flow quantities depend only on those of the functions Φ_V , Φ_p and Φ_T appearing in the numerators, and on that of the quantity $(M^2 - 1)$, which is present in

all denominators. Indeed, all the remaining quantities are positive by definition, since $k_g > 1$, as required by the general thermodynamical constraints, so that we always have $k_m > 1$ (Buresti & Casarosa 1989).

For the study of the functions Φ_v , Φ_p and Φ_T , it may be useful to introduce the following definitions:

$$\tan \alpha := \frac{D}{4A} \frac{dA}{dz}, \quad (51)$$

$$\tan \beta := \frac{gD}{4a_m^2}, \quad (52)$$

$$\tan \gamma := \frac{1}{2}f[1 + (k_m - 1)(1 + \eta\rho_g/\rho_p)], \quad (53)$$

$$\tan \delta := \frac{1}{2}f, \quad (54)$$

$$\tan \delta^* := \frac{1}{2}f(\eta\rho_g/\rho_p), \quad (55)$$

so that, we may write

$$\Phi_v = \frac{4}{D}(\tan \gamma M^2 - \tan \alpha + \tan \beta), \quad (56)$$

$$\Phi_p = \frac{4}{D}[(\tan \gamma - \tan \delta) M^4 - (\tan \alpha - \tan \delta) M^2 + \tan \beta], \quad (57)$$

$$\Phi_T = \frac{4}{D}[(\tan \gamma + \tan \delta^*) M^4 - (\tan \alpha + \tan \delta^*) M^2 + \tan \beta]. \quad (58)$$

The nature of the first of the quantities (51)–(55), $\tan \alpha$, has a purely geometrical character, and is a function of the coordinate z along the duct; in particular, if the duct is rectilinear and axisymmetric, the angle between the tangent to its generating curve and the axis is exactly α . The second parameter, $\tan \beta$, is both geometrical and physical, because it is a function of z through the hydraulic diameter D , of the duct and flow orientations through g , and of the thermodynamic state through the velocity of sound a_m . As regards the remaining quantities, if the friction coefficient may be assumed to be independent of the Reynolds number and a function only of the duct roughness (as is the case, for instance, for completely developed turbulent flow), then for a given duct $\tan \delta$ is a constant, while $\tan \gamma$ and $\tan \delta^*$ are dependent only on the thermodynamic state through the density of the gas phase; furthermore, all these three latter quantities are obviously non-negative.

A geometrical analysis will now be carried out to determine the signs of the variations of velocity, pressure and temperature as a function of the local flow conditions. To this end we will temporarily consider an auxiliary three-dimensional Euclidean space referred to the coordinates

$$X = \tan \alpha, \quad (59)$$

$$Y = M^2, \quad (60)$$

$$Z = \tan \beta. \quad (61)$$

In this space, the functions Φ_v , Φ_p and Φ_T in the form (56), (57) and (58) may be directly studied by assuming the quantities $\tan \gamma$, $\tan \delta$ and $\tan \delta^*$ to be simple parameters. If we now observe that the aforementioned functions are continuous with respect to all variables, the regions of space where they are positive or negative may be determined by analysing the loci of their zeros.

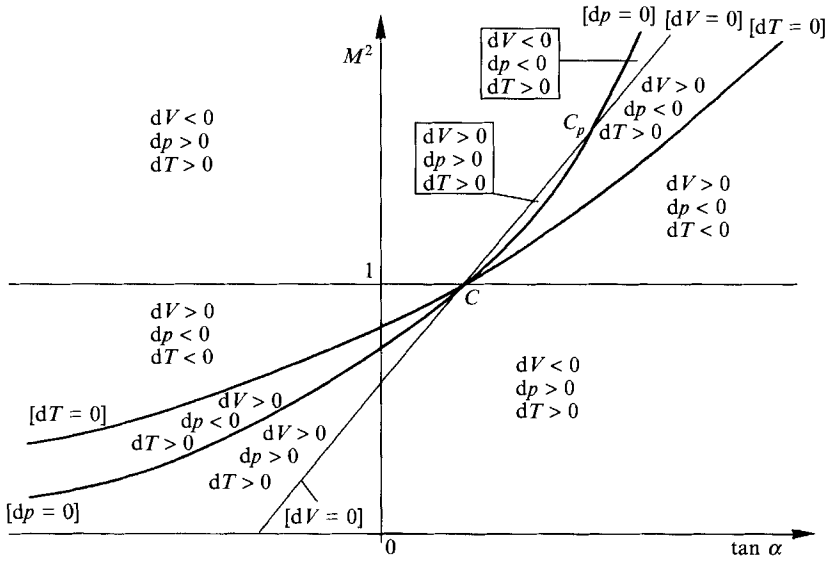

FIGURE 2. Local map of the signs of dV , dp and dT for $\tan \beta \leq -\tan \delta$.

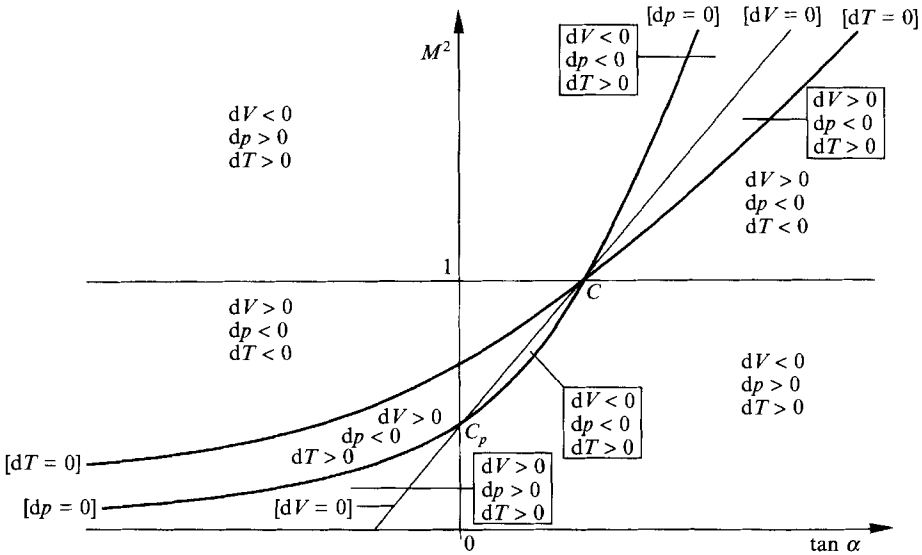

FIGURE 3. Local map of the signs of dV , dp and dT , for $-\tan \delta < \tan \beta < 0$.

We may then write

$$\Phi_V = 0 \Leftrightarrow \tan \gamma Y - X + Z = 0, \tag{62}$$

$$\Phi_p = 0 \Leftrightarrow (\tan \gamma - \tan \delta) Y^2 - (X - \tan \delta) Y + Z = 0, \tag{63}$$

$$\Phi_T = 0 \Leftrightarrow (\tan \gamma + \tan \delta^*) Y^2 - (X + \tan \delta^*) Y + Z = 0. \tag{64}$$

Accepting, for a moment, the negative- Y half-axis, which has actually no physical meaning, these expressions clearly represent surfaces in the space X, Y, Z ; the first one is simply a plane, while the other two are quadrics. In particular, as shown by Buresti & Casarosa (1992), they are hyperbolic paraboloids, i.e. saddle paraboloids. As well

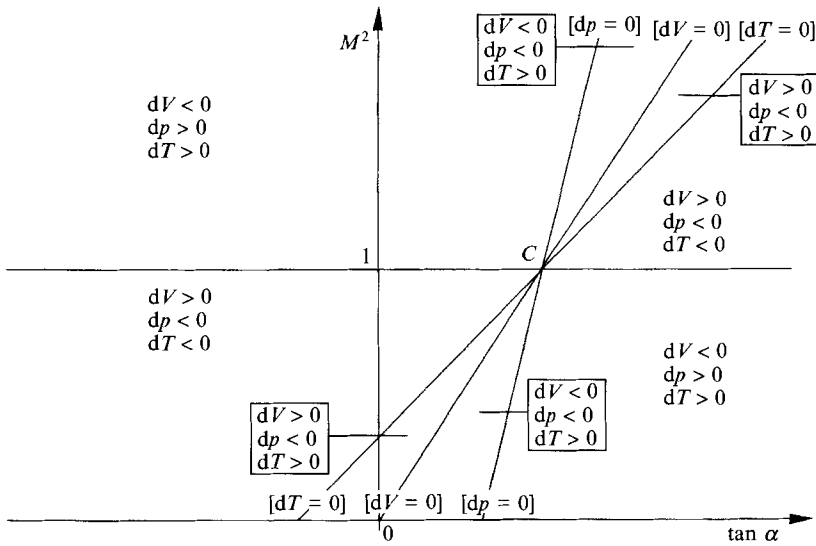

FIGURE 4. Local map of the signs of dV , dp and dT for $\tan \beta = 0$.

known, by sectioning a hyperbolic paraboloid with planes parallel to the principal ones, two sets of parabolas and one set of hyperbolas may be found. In our case it can be shown that the hyperbolas are obtained by means of sections with $Z = \text{constant}$ planes; in particular, the section with the plane $Z = 0$ gives the asymptotes of the hyperbolas.

A complete characterization of the intersections between the surfaces defined by (62), (63) and (64) is carried out in detail by Buresti & Casarosa (1992), who in particular show that these intersections are all straight lines. But the largest amount of information may be obtained by considering the relative positions of the sections of the surfaces with $Z = \text{constant}$ planes. Indeed, by considering these intersection patterns in the (X, Y) -plane, it is easy to see that at the left of each curve representing one of the surfaces (62), (63) and (64) the relevant function Φ_V , Φ_p or Φ_T is positive, while in the region at the right of that curve the function is negative. Therefore, if we also take the sign of the quantity $(M^2 - 1)$ into account, the sign of the local variations of the flow quantities in each region of the (X, Y) -plane bounded by the above-mentioned curves and by the line $Y = M^2 = 1$, may be derived immediately from (21)–(23).

The result of this analysis may be summarized in five maps (figures 2–6), corresponding to different values of the quantity Z , and where the sections of the surfaces (62), (63) and (64) are indicated as $dV = 0$, $dp = 0$ and $dT = 0$, respectively. Figures 2 and 3 correspond to downward flow, figure 4 to horizontal flow, and the last two (figures 5 and 6) to upward flow. In these figures the quantities $\tan \alpha$, M^2 and $\tan \beta$ have been reintroduced instead of X , Y and Z ; furthermore, three important intersection points appear, which are defined by the following coordinates:

$$C := \{ \tan \alpha = \tan \beta + \tan \gamma; M^2 = 1 \}, \tag{65}$$

$$C_p := \left\{ \tan \alpha = -\frac{\tan \gamma - \tan \delta}{\tan \delta} \tan \beta; M^2 = -\frac{\tan \beta}{\tan \delta} \right\}, \tag{66}$$

$$C_T := \left\{ \tan \alpha = \frac{\tan \gamma + \tan \delta^*}{\tan \delta^*} \tan \beta; M^2 = \frac{\tan \beta}{\tan \delta^*} \right\}. \tag{67}$$

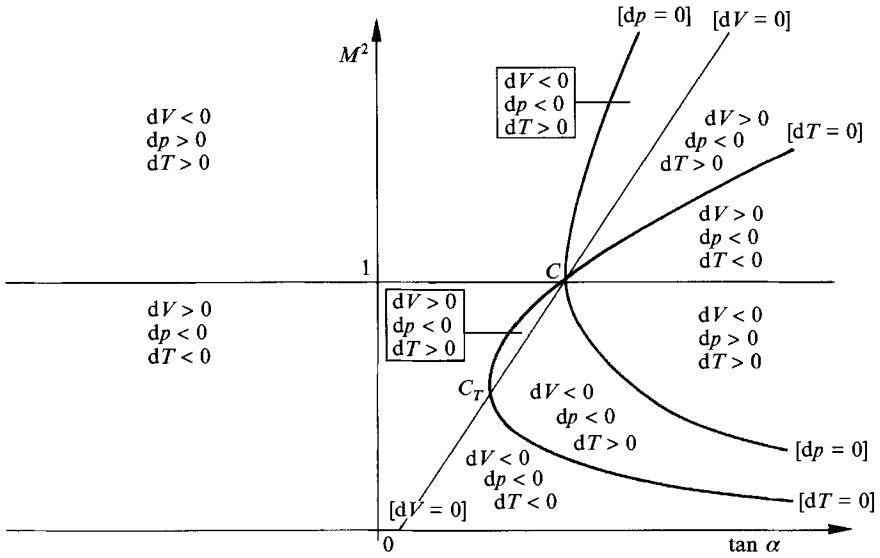

FIGURE 5. Local map of the signs of dV , dp and dT for $0 < \tan \beta \leq \tan \delta^*$.

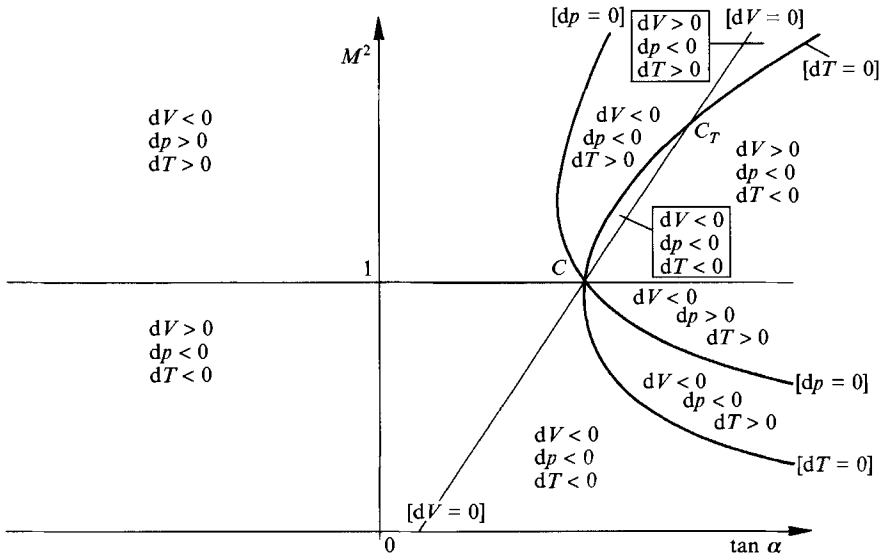

FIGURE 6. Local map of the signs of dV , dp and dT for $\tan \delta^* < \tan \beta$.

It is immediately possible to check that the conditions corresponding to point C are exactly those defined by relation (27); in other words, point C is a singular point whose presence is a necessary condition for transition between subsonic and supersonic flow to occur. Furthermore, as now only conditions corresponding to $M^2 > 0$ are considered, point C_p is of interest only in downward flow ($\tan \beta < 0$) and point C_T only in upward flow ($\tan \beta > 0$).

As a comment on all the maps (which are obviously only qualitative) it should be pointed out that they are not invariant with the flow, but have a real local nature, i.e. the positions of the various curves vary with the local conditions of motion. Indeed, each map relates to given values of $\tan \beta$, $\tan \gamma$, $\tan \delta$, $\tan \delta^*$: as already stated at the

beginning of the section, the first of these parameters depends on the duct geometry and on the thermodynamic state, whereas the other three depend only on the friction coefficient and on the thermodynamic state. Therefore, the flow conditions existing at a certain section of the duct completely identify the applicable map, the actual position of the curves, and the point representing the flow state; this provides the desired information on the local variation of the flow quantities.

It is important to observe that the present model, and thus the solution of the differential equations (21)–(23), is continuous in nature. In other words, given the continuity of the functions $V(z)$, $p(z)$ and $T(z)$, and therefore of the flow conditions, it must be concluded that with varying axial coordinate z the maps deform with continuity, and that the representative points move continuously on the maps as well.

Independently of the local nature of the analysis carried out so far, further interesting indications of general character may be derived from these figures. In particular, it is seen that the flow model expressed by (21)–(23) does not admit all the eight possible distinct combinations of the signs of the variations of the flow quantities; indeed, only six of them are compatible with the model, each one corresponding to one or more of the regions present in the maps. All this is synoptically reported in table 1, where it is apparent that the two conditions corresponding to $\tan \beta < 0$ actually give rise to the same admissible cases.† However, from figures 2 and 3 it is seen that case 2 may occur in supersonic flow only if $\tan \beta < -\tan \delta$. A similar situation occurs for the two conditions corresponding to $\tan \beta > 0$, as from figures 5 and 6 it can be derived that case 7 can be found in supersonic flow only if $\tan \beta > \tan \delta^*$.

As can be seen from the analysis of table 1, the two non-admissible cases, namely cases 1 and 8, are those characterized by simultaneous compression and adiabatic cooling of the mixture, i.e. by $dp > 0$ and $dT < 0$. The explanation of this result is connected with the fulfilment of the second law of thermodynamics, which has implicitly been imposed when it has been assumed that $f > 0$. Indeed, it is easy to obtain (Buresti & Casarosa 1990) that

$$\frac{dS_m}{C_{p_m}} = \frac{(k_m - 1) M^2 4f}{2D} (1 + \eta \rho_g / \rho_p)^2 dz > 0. \quad (68)$$

By considering now (10), we have

$$dS_m \geq 0 \Leftrightarrow \frac{dT}{T} \geq \frac{R_m}{C_{p_m}} \frac{dp}{p}, \quad (69)$$

which is obviously not compatible with cases 1 and 8.

Among the admissible cases, some are rather unusual, if compared with the results of ordinary inviscid gasdynamics. In particular, cases 2 and 7, which are respectively limited to downward and upward flow, are striking because they are characterized by concordant signs of the variations of velocity, pressure and temperature. Noteworthy are also cases 3 and 6, in which the expansion and the heating of the mixture take place simultaneously, respectively with an acceleration and a deceleration of the flow.

The possibility of the occurrence of an acceleration of the flow with expansion and adiabatic heating of the mixture, i.e. of case 3, had already been proved by Buresti &

† If, besides the positive and negative signs, the zero variation of the flow quantities is considered as well, then there are 27 possible cases, but only 14 are compatible with the model. These can easily be obtained from the maps by adding to the six admissible cases of table 1 those arising from considering couples of contiguous regions, and from the nature of the vanishing function in the curve dividing those regions.

Case	dV	dp	dT	tan β < 0		tan β = 0		tan β > 0	
				(tan β ≤ -tan δ)	(-tan δ < tan β)	(tan β ≤ 0)	(tan β ≤ tan δ*)	(tan δ* < tan β)	
1	> 0	> 0	< 0	NO	NO	NO	NO	NO	
2	> 0	> 0	> 0	YES	YES	NO	NO	NO	
3	> 0	< 0	> 0	YES	YES	YES	YES	YES	
4	> 0	< 0	< 0	YES	YES	YES	YES	YES	
5	< 0	> 0	> 0	YES	YES	YES	YES	YES	
6	< 0	< 0	> 0	YES	YES	YES	YES	YES	
7	< 0	< 0	< 0	NO	NO	NO	YES	YES	
8	< 0	> 0	< 0	NO	NO	NO	NO	NO	

TABLE 1. Admissible variations of the flow quantities

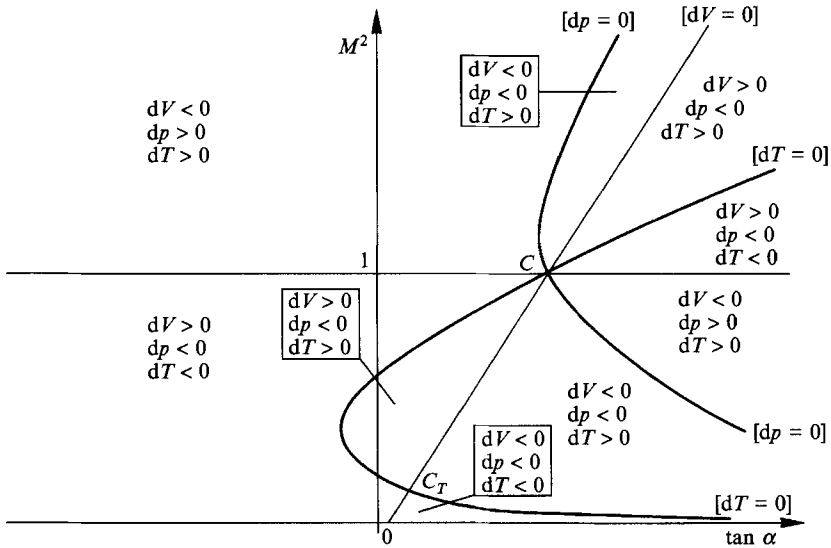

FIGURE 7. Particular case of figure 5 for $0 < \tan \beta < (\tan \delta^*)^2 / [4(\tan \gamma + \tan \delta^*)]$.

Casarosa (1989) for upward or horizontal subsonic flow in constant-section ducts. That result is now shown to be a particular case corresponding to a map of the type of figure 5, when the hyperbola relative to $dT = 0$ has its vertex to the left of the vertical axis, as exemplified in figure 7. It may be shown (Buresti & Casarosa 1992) that a map of this type occurs when

$$\tan \beta < \frac{(\tan \delta^*)^2}{4(\tan \gamma + \tan \delta^*)} < \tan \delta^* \tag{70}$$

and this condition may easily be demonstrated to be equivalent to that expressed in terms of temperature by Buresti & Casarosa (1989). In fact, by considering figure 7 it may be seen that for flow in constant-section ducts ($\tan \alpha = 0$), there are in this case two intersections between the vertical axis and the curve corresponding to $dT = 0$, so that two limit Mach numbers exist, which bracket conditions in which the heating of the mixture takes place simultaneously with its acceleration and expansion.

Obviously, from the maps and from the expressions representing the various curves, the limits of existence of the different cases defined in table 1 may easily be obtained in analytical form. Furthermore, particular flow conditions may be studied without difficulty, thus retrieving the relevant, more classical, flow behaviour. For instance, it is immediately derived that if the usual assumption of negligible volume of the particles is made (by putting $\rho_p = \infty$), then in the case of horizontal flow ($\tan \beta = 0$) and constant cross-section ($\tan \alpha = 0$) case 3 of table 1 ($dV > 0$, $dp < 0$, $dT > 0$) is never possible, as already pointed out by Buresti & Casarosa (1989). This result may now be extended to upward flow ($\tan \beta > 0$), because the condition corresponding to figure 5 may also never occur, while from (67) it is seen that point C_T in figure 6 moves to infinity, so that again case 3 can never be found.

In conclusion, the information deriving from the previous analysis, and summarized in figures 2-7 and in table 1, allows the variation of the flow quantities at a given condition to be identified, and the compatibility of the various cases with the assumed flow model to be assessed. Moreover, some further knowledge of the flow may be deduced by means of relation (19).

Indeed, given the flow conditions, thus identifying a map and a point on it, the variations $d(\tan \alpha)$ and $d(M^2)$ define in the half-plane $\tan \alpha - M^2$ the direction tangent to the integral curve representing the motion in the neighbourhood of the point representing the flow conditions. The variation $d(\tan \alpha)$ depends only on the shape of the duct; for $d(M^2)$, we may resort directly to relation (19) and show that only in the following cases can the sign of this variation be determined in advance, from the knowledge of the sign of the variations of velocity, pressure and temperature:

(i) $\rho_g \leq \rho_p/\eta$:

$$\text{if } dV > 0, \quad dp < 0, \quad dT < 0 \Rightarrow dM > 0 \Rightarrow dM^2 > 0, \quad (71)$$

$$\text{if } dV < 0, \quad dp > 0, \quad dT > 0 \Rightarrow dM < 0 \Rightarrow dM^2 < 0, \quad (72)$$

(ii) $\rho_g > \rho_p/\eta$:

$$\text{if } dV > 0, \quad dp < 0, \quad dT > 0 \Rightarrow dM > 0 \Rightarrow dM^2 > 0, \quad (73)$$

$$\text{if } dV < 0, \quad dp > 0, \quad dT < 0 \Rightarrow dM < 0 \Rightarrow dM^2 < 0. \quad (74)$$

Relations (71) and (72) refer, respectively, to cases 4 and 5 of table 1 and are thus valid in four distinct regions, two subsonic and two supersonic, which are present in each map. When in these regions $\rho_g \leq \rho_p/\eta$, the variations of the flow quantities are in agreement with what might be expected from ordinary inviscid gasdynamics.

Relations (73) correspond to case 3 of table 1, which applies to two distinct regions, one subsonic and one supersonic, in each map, with the exception of that of figure 6 ($\tan \beta > \tan \delta^*$), in which it applies to a single supersonic region. Conversely, relations (74) refer to case 8 of table 1, and therefore may never occur in the present model.

In cases different from those considered above, nothing can be said in advance about the sign of dM , which must then be evaluated at each station through relation (19), and this fact may render the integration of the equations of motion by using the Mach number as an independent variable a much more difficult procedure. Consequently, this method of integration, which was extensively used by Buresti & Casarosa (1989), preferably should be applied only in the cases described above, and in particular when the desired conditions correspond to the sonic choking of the flow, or to the transition from subsonic to supersonic motion.

Finally, it should be pointed out that Buresti & Casarosa (1992) also describe another method of geometrical analysis, which leads to results that are similar to those reported in table 1, but corresponds to a slightly different point of view. In particular, the relevant maps, although apparently simpler, because the various zones are bounded only by straight lines, are probably less suitable for the physical description of the flow in practical applications. For further details reference can be made to that report.

4. Applications

The model described and discussed in the previous sections will now be used to determine the flow of gas-particle mixtures in conditions which may represent typical volcanological applications. In particular, the geometry of the ducts, the initial conditions and the characteristics of the phases that will be considered are described in figure 8; as may be seen, the type 1 ducts have converging-diverging circular cross-section, while the type 2 ducts are characterized by constant-diverging cross-sections. In the figure the slight curvature at the throat (composed of two circular arcs), which is necessary to avoid a discontinuity in the variation of the section and to assure a smooth numerical integration, is not shown. In all cases the flow is upward vertical,

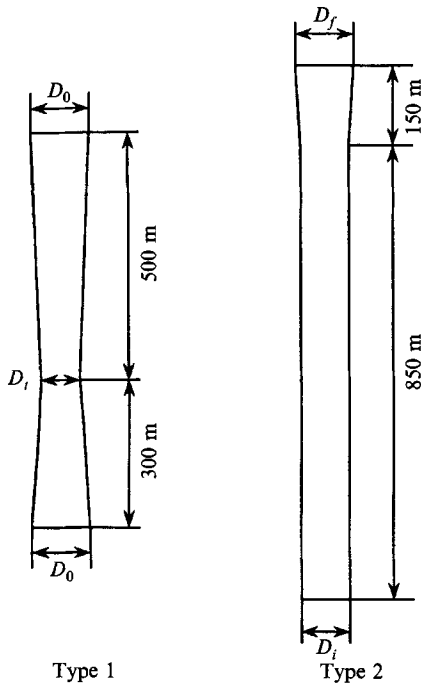

Type of gas: H₂O
 Particle density, ρ_p : 2600 kg/m³
 Specific heat of particles, C : 837 J/kg K
 Friction coefficient, f : 0.01

Duct orientation: upward vertical
 Initial and final diameters (type 1), D_0 : 50 m
 Throat diameter (type 1), D_i : 30 m, 40 m, 50 m
 Initial diameter (type 2), D_i : 30 m
 Final diameter (type 2), D_j : 30 m, 40 m, 45 m

Initial temperature, T_i : 850 °C
 Initial pressure, P_i : 10 MPa (type 1), 20 MPa (type 2)

FIGURE 8. Geometry of the ducts, characteristics of the phases and initial conditions for the present applications of the model.

and is assumed to be choked; a quick check of the numerical values of the various quantities defined in §3.3 shows that the initial conditions always correspond to $\tan \beta > \tan \delta^*$, i.e. to the map of figure 6, and to case 4 of table 1.

Consequently, as relations (71) are satisfied, an integration procedure based on a fourth-order Runge-Kutta method with the Mach number as the independent variable and the coordinate z as one of the unknowns was used (Buresti & Casarosa 1990). When it may be applied, this procedure is very advantageous; in fact, even if it is not possible to obtain a closed-form integration as was the case for the flow of a perfect gas in ducts with friction (Shapiro 1953), we may still take advantage of the fact that for a value of the Mach number known in advance ($M = 1$) the solution shows predictable topological behaviour.

For instance, if the condition $M = 1$ is reached in a section where the functions Φ_v , Φ_p and Φ_T are $\neq 0$, then we have seen in §3.2 that the solution has a 'turning point', the flow is 'choked', and that section can only be the final one of the duct. This condition is typical of constant-area or converging ducts, provided the pressure in the outlet environment is sufficiently low. The solution may then be obtained by iteratively changing the value of the Mach number in the initial section until the condition $M = 1$ is reached exactly at the exit of the given duct.

Conversely, if the geometry of the duct is such that $M = 1$ in a section where simultaneously $\Phi_v = \Phi_p = \Phi_T = 0$, i.e. where condition (27) is fulfilled, then the solution there has a singular point, whose topological character is a function of the local conditions of the flow. If we then consider ducts with converging-diverging cross-section, with subsonic inlet flow and choked conditions, then the flow downstream of the critical section where $M = 1$ may follow different solutions according to the value of the pressure in the outlet environment. If the latter is assumed to be sufficiently low,

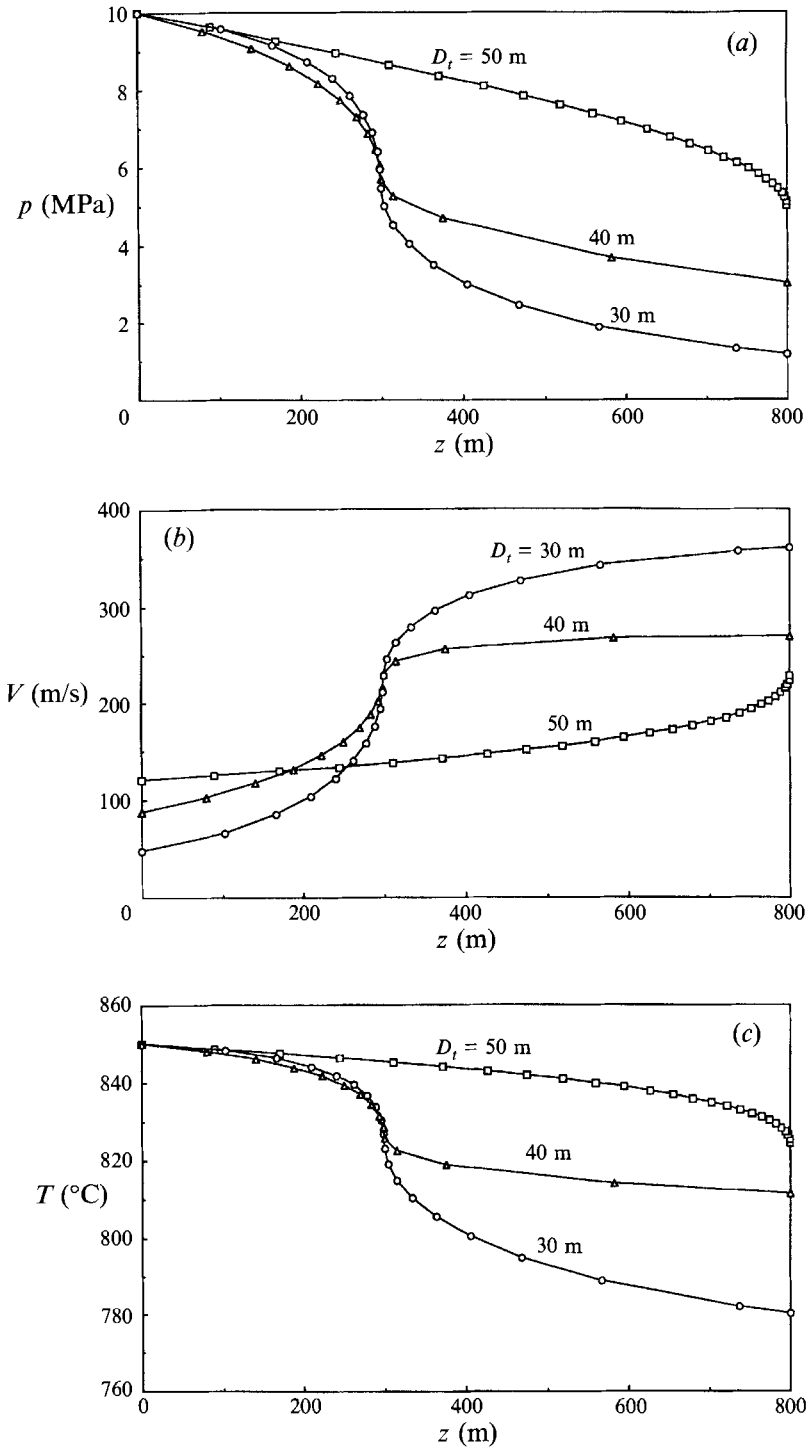

FIGURE 9. (a) Pressure, (b) velocity and (c) temperature variation for type 1 ducts, $\eta = 10$.

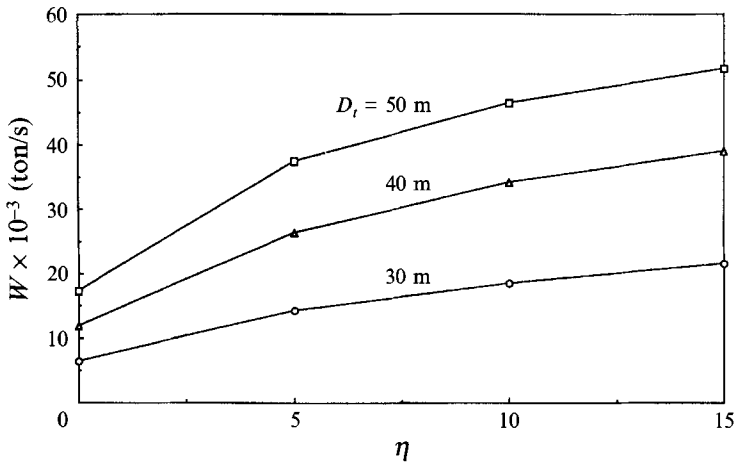

FIGURE 10. Variation of the mass flow rate as a function of loading ratio for type 1 ducts with different throat diameters.

then we will have a supersonic shock-free flow. In this case the integration in terms of Mach number allows a convenient procedure to be devised for the smooth crossing of the critical section. Indeed, the inlet value of M may be iteratively varied until in the section for which $M = 1$ we have simultaneously $\Phi_v = \Phi_p = \Phi_T = 0$. Afterwards, M is increased until z reaches the value L corresponding to the length of the duct, and the final conditions (also in terms of Mach number) are obtained.

Obviously, for this scheme to be applied conditions should be such that shock waves are not present in the duct. As already pointed out, this implies that the calculated pressure in the final section of the duct must be higher than (or, at least, equal to) the pressure of the outlet environment; this assumption, which is a quite reasonable one for the volcanological application of the model, was made in all the cases described in the present section.

For the type 1 ducts of figure 8, figure 9(a) shows the variation of the pressure along the duct obtained for various values of the throat diameter (including the one corresponding to constant-section duct), for a loading ratio $\eta = 10$. The great difference between the constant-section case ($D_t = 50$ m) and those with variable cross-section is immediately apparent; in particular there is a large reduction in the outlet pressure with decreasing throat diameter. Similarly, the variations of the velocity are strongly dependent on the contraction of the duct, as clearly shown by figure 9(b). Indeed, while in the constant-section duct the velocity gradually increases along all the duct length up to the local sound velocity at the outlet section, by decreasing D_t the velocity becomes sonic immediately downstream of the throat, and then increases to supersonic values (which become larger with decreasing D_t); simultaneously, there is a velocity decrease in the initial section, with a consequent decrease of the mixture mass flow rate. The behaviour of the temperature for the cases analysed is reported in figure 9(c), which shows that the assumption of isothermal flow is certainly much less accurate if variations of the cross-section are present in the duct. Finally, the significant reduction of the mass flow rate with decreasing throat diameter is shown in figure 10.

It should be pointed out that in the variable-section cases the gradients of the various quantities are high in the zone of the throat, so that in that portion of the duct the validity of the assumption of thermomechanical equilibrium between gas and particles might be doubtful. Nevertheless, provided the dimensions of the particles are

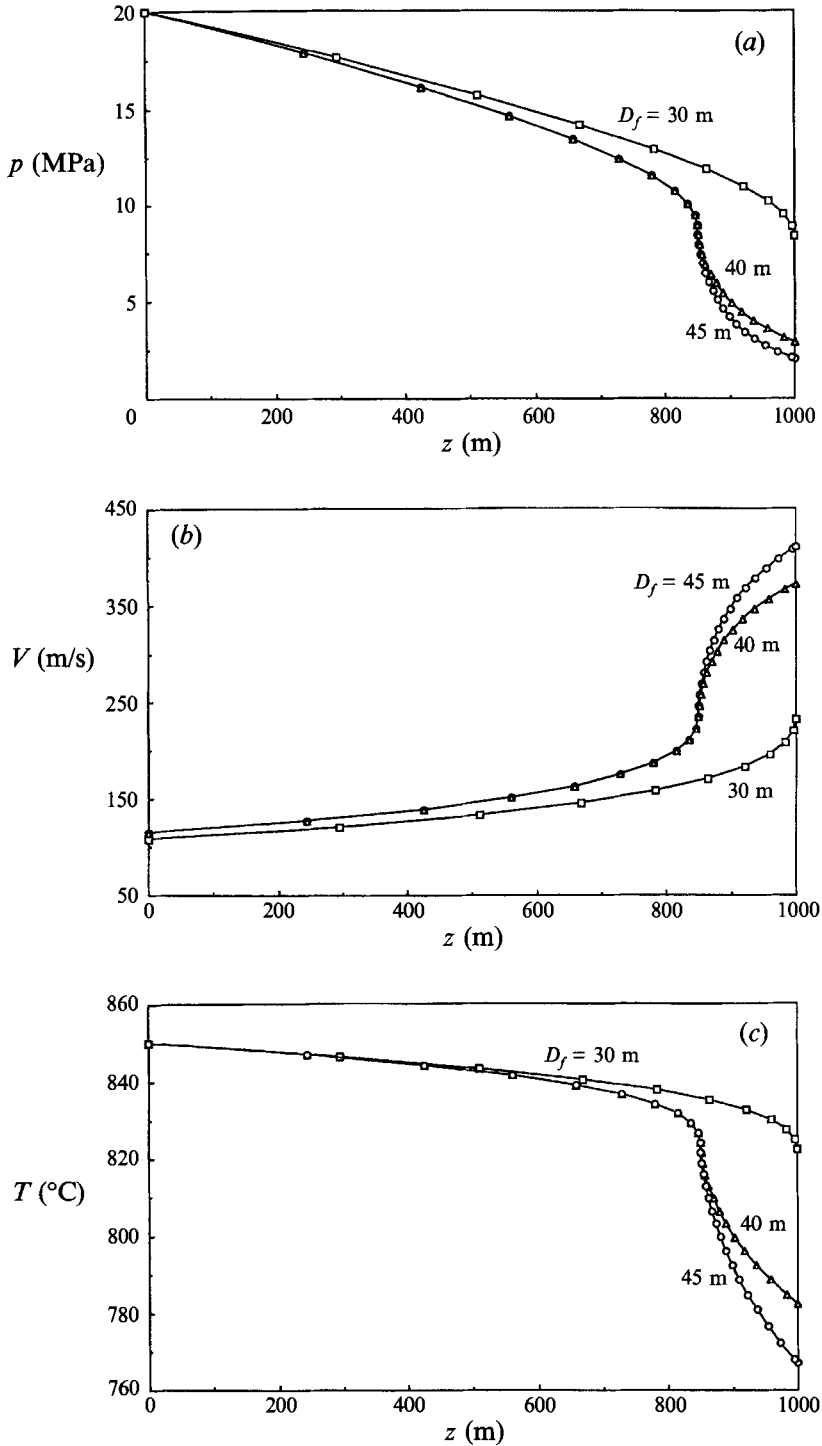

FIGURE 11. (a) Pressure, (b) velocity and (c) temperature variation for type 2 ducts, $\eta = 10$.

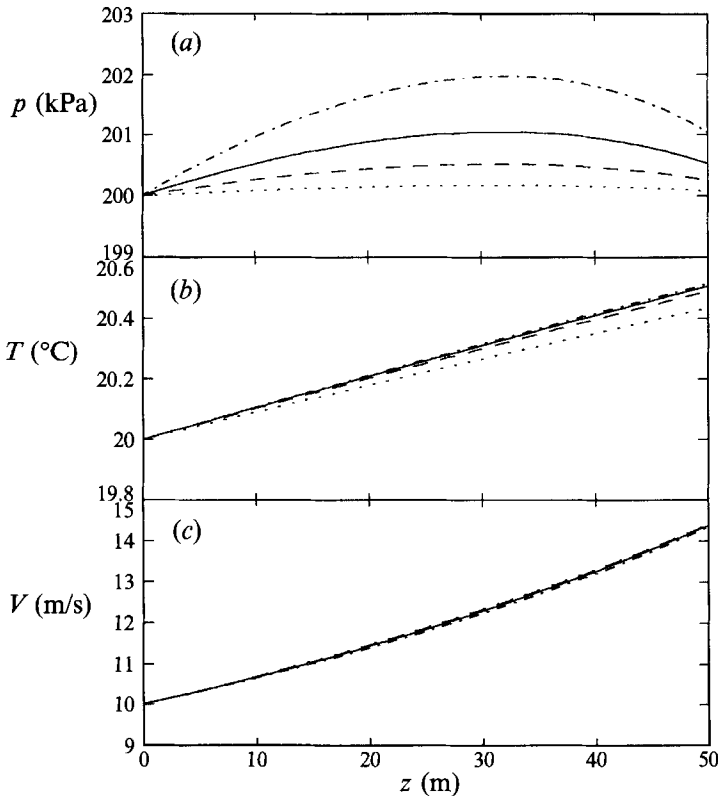

FIGURE 12. (a) Pressure, (b) temperature and (c) velocity variation in the downward flow along a vertical converging duct. Gas phase: air; $\rho_p = 2600 \text{ kg m}^{-3}$; $4f/D_t = 0.1 \text{ m}^{-1}$; $\tan \alpha = -0.0005$, $\eta = 0$; ---, $\eta = 2$; —, $\eta = 5$; - · - · -, $\eta = 10$.

sufficiently small, i.e. less than approximately 0.1 mm in the present cases (a plausible value for intense explosive eruptions, as reported by Dobran, Neri & Macedonio 1992), it is extremely probable not only that the qualitative behaviour of the results is correct, but also that the numerical values obtained may represent the actual conditions of motion with a good degree of approximation. In fact, it may easily be checked that the time the particles require for crossing the high-gradient regions, evaluated from the numerical solutions, is one order of magnitude higher than their relaxation times (obtained as in Buresti & Casarosa 1987), so that conditions (1)–(3) may be considered to be acceptably fulfilled.

The results obtained for the type 2 ducts of figure 8 as regards pressure, velocity and temperature are shown in figure 11. As could be expected, the cases with a diverging final portion are characterized by identical flow conditions in their constant-section initial part, at the end of which the sonic velocity is always achieved. Conversely, in the diverging portions different conditions are found as a function of the divergence angle, and different pressures and velocities are reached in the final section. The mass flow rate is then the same for the two cases, and larger than that obtained in the duct with entirely constant cross-section, in which the initial velocity is lower and the sonic conditions are reached at the outlet section. The same comments made before as regards the accuracy and applicability of the model are relevant also in this case. Furthermore, the variation of the temperature confirms again that in variable-section ducts the assumption of isothermal flow may be questionable.

Finally, in order to describe a case in which the behaviour of the flow quantities is somewhat less usual, in figure 12 the results are shown of an example of an application in which a simultaneous increase in pressure, temperature and velocity is present. In this case the downward flow of a mixture of air and siliceous particles in a very slightly converging duct ($\tan \alpha = -0.0005$) is considered; the duct is 50 m long and the initial conditions are $T_i = 20^\circ\text{C}$, $p_i = 0.2\text{ MPa}$, $V_i = 10\text{ m s}^{-1}$ and $4f/D_i = 0.1\text{ m}^{-1}$ (corresponding to $f = 0.0075$ and $D_i = 0.3\text{ m}$), and $\tan \beta < -\tan \delta$, so that the possible variations of the flow quantities are described by a map like that of figure 2. The results are shown for values of the loading ratio η from 0 to 10, and it is interesting to note that only the pressure variation is significantly affected by this parameter. Furthermore, the simultaneous increase of the three quantities, i.e. the occurrence of case 2 of table 1, is seen to take place even for a pure gas up to lengths of slightly above 30 m, while further downstream the pressure decreases, i.e. the conditions change to those corresponding to case 3.

5. Conclusions

In the present paper a one-dimensional model for the evaluation of the steady adiabatic motion of homogeneous gas-particle mixtures in generically oriented ducts, with variable cross-section and wall friction, is described. The particles are assumed to be incompressible and in thermomechanical equilibrium with a perfect gas phase, and the effects of their finite volume are also taken into account. The model is a generalization of the one originally developed for upward vertical flow in constant-section ducts by Buresti & Casarosa (1987, 1989), whose main purpose was the description of the flow of magmatic fluid along volcanic conduits during certain phases of explosive eruptions. For the same volcanological application, the present extension allows the effects of variations of the cross-section to be taken into account, provided they are sufficiently gradual to ensure that the assumptions of thermomechanical equilibrium and one-dimensionality are still valid. It may then be used for a first-order study of the flow downstream of the disruption zone in high-intensity Plinian eruptions, and, in particular, to rapidly analyse the effects of variations of the geometry of the volcanic conduit, of the composition of the fluid and of its thermomechanical state, thus providing the necessary initial conditions for models describing the dynamics of the external volcanic columns (Dobran *et al.* 1992).

However, the complete generality of the present model, which may be applied to the motion in ducts of any orientation as long as equilibrium gas-particle mixtures (or real gases with equivalent equations of state) are considered, allowed an exhaustive theoretical analysis of the possible behaviour of the solutions to be carried out.

In particular, it was possible to apply to the model the procedure of Bilicki *et al.* (1987) to determine the existence, position and topological classification of the singular points of the trajectories representing, in a suitable phase space, the solutions of the set of equations defining the problem. Apart from its intrinsic theoretical interest in the study of the behaviour of the flow as a function of the geometry and of the thermomechanical conditions, this analysis permits numerical difficulties that may arise in the neighbourhood of these singular points to be overcome.

Subsequently, a geometrically based analysis was carried out to determine the possible qualitative trends of velocity, pressure and temperature along the duct as a function of the geometrical and fluid dynamical parameters defining the motion. The knowledge of these trends of the flow quantities may be of help, particularly in those cases in which they are not in agreement with those of the classical gasdynamics of

perfect gases. Actually, it is well known that variations of the equation of state may affect the behaviour of the flow quantities, but it may be useful to verify and characterize the possibility of occurrence of trends which are significantly at variance with the more usual ones. This is one of the results of the present analysis, and generalizes the findings of Buresti & Casarosa (1989), who had already demonstrated that in an upward or horizontal flow in constant-section ducts conditions exist in which an acceleration may occur together with an expansion and an adiabatic heating of the mixture. Now the possibility of further unusual behaviour has been found for motion in variable-area ducts; in particular, in an upward flow we may have a simultaneous decrease of velocity, pressure and temperature, while in a downward flow an increase of all these three quantities may be found. It is also shown that in a decelerating flow the expansion and the heating of the mixture may take place simultaneously, whereas the impossibility of simultaneous compression and adiabatic cooling of the mixture is theoretically demonstrated.

An important result of both the topological and geometrical analyses is the exact definition of the requirements for the transition from subsonic to supersonic flow, in terms of both geometry of the duct and local flow conditions. Actually, the correct design of this transition zone requires special care, as does the numerical integration of the equations in the same region, particularly when choked flow conditions are analysed and the Mach number is used as the independent variable.

Finally, the application of the model to the study of the upward motion of gas-particle mixtures in particular ducts, with converging-diverging or constant-diverging cross-sections, showed that even limited and gradual variations in the duct diameter may give rise to significant variations in the flow conditions inside the duct and in the mass flow rate. This fact has significant implications as far as the volcanological application is concerned, and clearly shows that simple models may have an important role in the lengthy parametric analyses which are necessary to assess the relative importance of all the quantities involved in that problem.

The present work was partially supported by the Consiglio Nazionale delle Ricerche, Gruppo Nazionale per la Volcanologia.

REFERENCES

- ABBOTT, M. M. & VAN NESS, H. C. 1972 *Thermodynamics*. McGraw Hill.
- BILICKI, Z., DAFERMOS, C., KESTIN, J., MAJDA, G. & ZENG, D. L. 1987 Trajectories and singular points in steady-state models of two-phase flows. *Int'l J. Multiphase Flow* **13**, 511-53.
- BOOTHROYD, R. G. 1971 *Flowing Gas-Solid Suspensions*. Chapman and Hall.
- BURESTI, G. & CASAROSA, C. 1987 A one-dimensional model for the flow of equilibrium gas-particle mixtures in vertical ducts with friction and its application to volcanological problems. *Atti del Dipartimento di Ingegneria Aerospaziale*, ADIA 87-3. Pisa: ETS Editrice.
- BURESTI, G. & CASAROSA, C. 1989 One-dimensional adiabatic flow of equilibrium gas-particle mixtures in long vertical ducts with friction. *J. Fluid Mech.* **203**, 251-272.
- BURESTI, G. & CASAROSA, C. 1990 A one-dimensional model for the flow of equilibrium gas-particle mixtures in variable-area ducts with friction. *Atti del Dipartimento di Ingegneria Aerospaziale*, ADIA 90-1. Pisa: ETS Editrice.
- BURESTI, G. & CASAROSA, C. 1992 Geometrical and topological analysis of the one-dimensional flow of homogeneous gas-particle mixtures in variable-area ducts with friction. *Atti del Dipartimento di Ingegneria Aerospaziale*, ADIA 92-4, Pisa: ETS Editrice.
- CROWE, C. T. 1982 Review - Numerical models for dilute gas-particle flows. *Trans. ASME I: J. Fluids Engng* **104**, 297-303.

- DOBTRAN, F. 1992 Nonequilibrium flow in volcanic conduits and application to the eruption of Mt. St. Helens on May 1980, and Vesuvius in AD 79. *J. Volcanol. Geotherm. Res.* **49**, 285–311.
- DOBTRAN, F., NERI, A. & MACEDONIO, G. 1992 Numerical simulation of collapsing volcanic columns. *C.N.R. Gruppo Nazionale per la Vulcanologia, Volcanic Simulation Group, Pisa, Rep. VSG 92-2*.
- GIBERTI, G. & WILSON, L. 1990 The influence of geometry on the ascent of magma in open fissures. *Bull. Volcanol.* **52**, 515–521.
- KAPLAN, W. 1958 *Ordinary Differential Equations*. John Wiley & Sons.
- KIEFFER, S. W. 1982 Dynamics and thermodynamics of volcanic eruptions: implications for the plumes on Io. In *Satellites of Jupiter* (ed. D. Morrison), pp. 647–723, University of Arizona Press.
- RUDINGER, G. 1976 Fundamentals and applications of gas–particle flow. In *AGARD-AG-222*, pp. 55–86.
- SHAPIRO, A. H. 1953 *The Dynamics and Thermodynamics of Compressible Fluid Flow*. John Wiley & Sons.
- SOO, S. L. 1989 *Particulates and Continuum: Multiphase Fluid Dynamics*. Hemisphere.
- VAN WYLEN, G. J. & SONNTAG, R. E. 1976 *Fundamentals of Classical Thermodynamics*. John Wiley & Sons.
- WALLIS, G. B. 1969 *One-dimensional Two-Phase Flow*. McGraw-Hill.
- WILSON, L. & HEAD, J. W. III 1981 Ascent and eruption of basaltic magma on the Earth and Moon. *J. Geophys. Res.* **86**, 2971–3001.
- WILSON, L., SPARKS, R. S. J. & WALKER, G. P. L. 1980 Explosive volcanic eruptions – IV. The control of magma properties and conduit geometry on eruption column behaviour. *Geophys. J. R. Astron. Soc.* **63**, 117–148.